



QUAKER
COMMERCIAL WINDOWS AND DOORS

**ALUMINUM 3 1/4" & 2 3/8" FRAME
MULLIONS, MULL COVERS,
POST FRAMING & MULL ACCESSORIES**

Standard C-Mull
M6270



3 1/2" Mull Cover w/Cap
M21664 & M536207

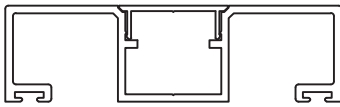

4" Mull Cover w/Cap
M536208 & M536207

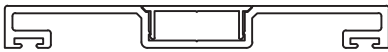

5 1/2" Mull Cover w/Cap
M536206 & M536207



7" Mull Cover w/Cap
M12794 & M536207

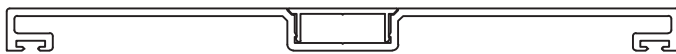

2" x 3" Reinforcing Tube w/Cap
M21586 & M536207

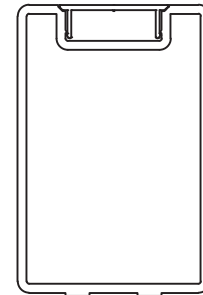

.094
WALL

2" x 3" Tube End Cap
RCR111554A

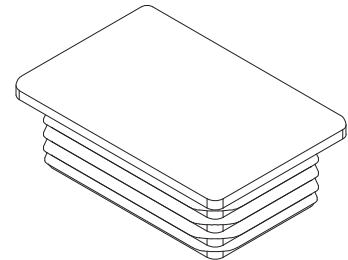

Our products are tested to the standards of and certified by the American Architectural Manufacturer's Association, the National Fenestration Rating Council and the Window & Door Manufacturers Association.



QUAKER
COMMERCIAL WINDOWS AND DOORS



QUAKER
COMMERCIAL WINDOWS AND DOORS

**ALUMINUM 3 1/4" & 2 3/8" FRAME
MULLIONS, MULL COVERS,
POST FRAMING & MULL ACCESSORIES**

2" X 4" Post

MW23225 & MW23397

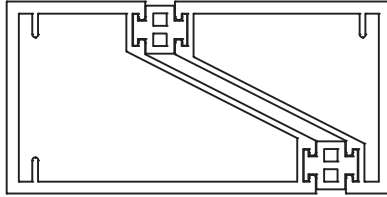

Post Thermal

BRS-3835



2" X 5" Post

MW23225 X 2

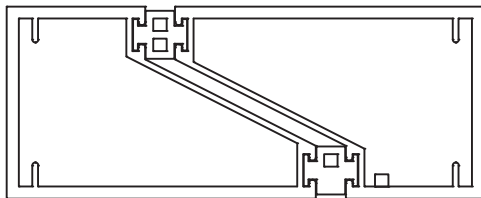

2" X 6" Post

MW23225 & MW23226

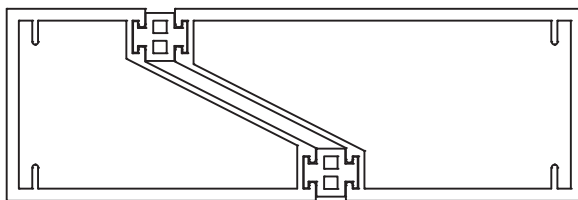

Our products are tested to the standards of and certified by the American Architectural Manufacturer's Association, the National Fenestration Rating Council and the Window & Door Manufacturers Association.



QUAKER
COMMERCIAL WINDOWS AND DOORS



QUAKER
COMMERCIAL WINDOWS AND DOORS

**ALUMINUM 3 1/4" & 2 3/8" FRAME
MULLIONS, MULL COVERS,
POST FRAMING & MULL ACCESSORIES**

2-Part 6" Square Post

M17033

(Fits together with C-Mull)

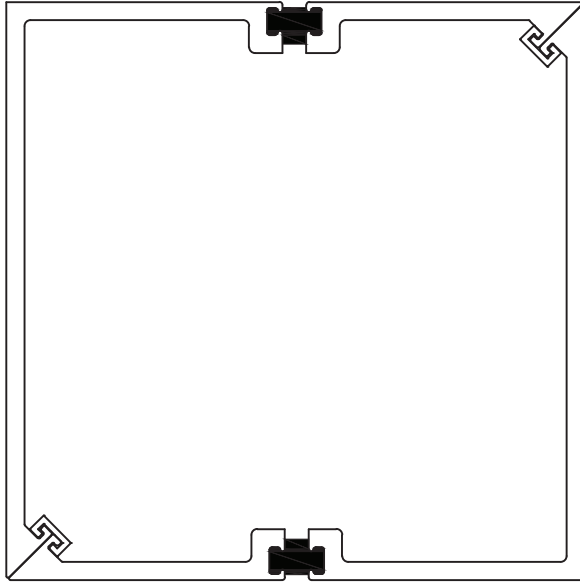

2-Part 4" Square Post

M19311

(Fits together with C-Mull)

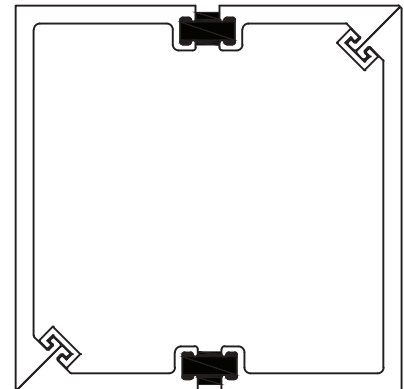
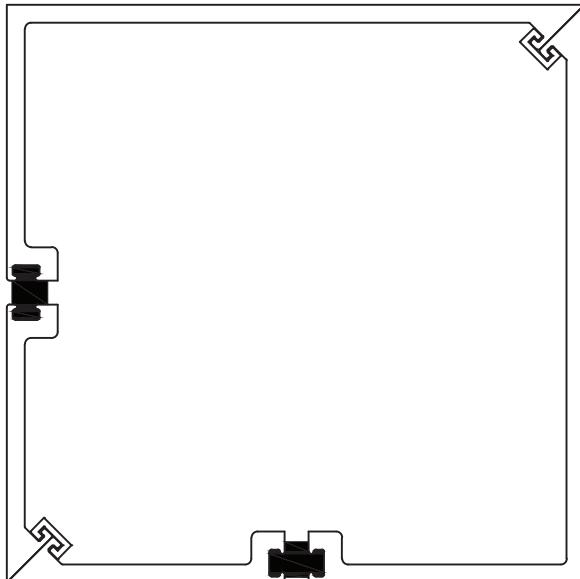
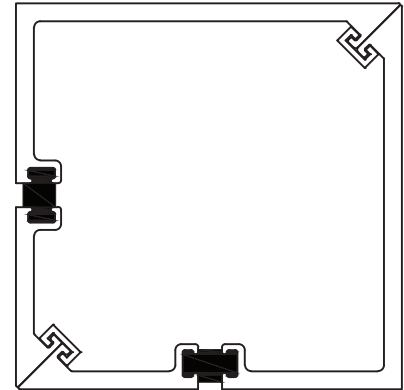

Our products are tested to the standards of and certified by the American Architectural Manufacturer's Association, the National Fenestration Rating Council and the Window & Door Manufacturers Association.



QUAKER
COMMERCIAL WINDOWS AND DOORS



QUAKER
COMMERCIAL WINDOWS AND DOORS

**ALUMINUM 3 1/4" FRAME
MULLIONS, MULL COVERS,
POST FRAMING & MULL ACCESSORIES**

Box T-Mullion & Box Cover

M20846 (T-Mull)
MAX17386 (Base)
M20845 (Cap)

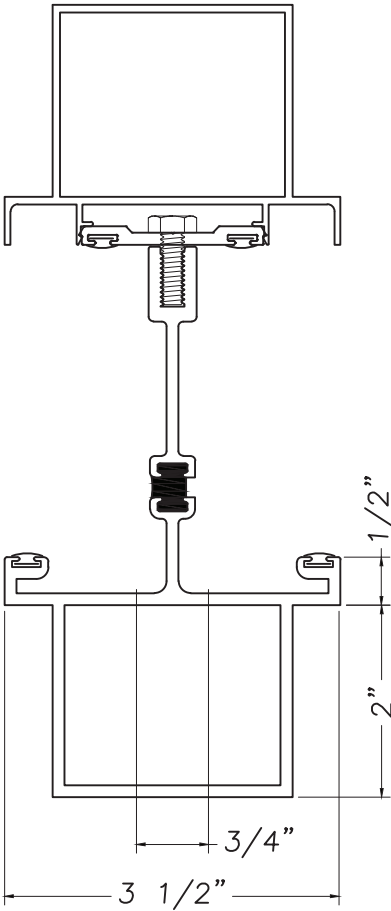

MS 1/2" Mullion
M21382

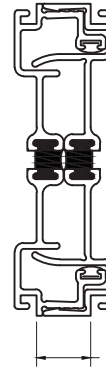

FS 1/2" Mullion
M21383

2" Structural T-Mull w/2" Offset Mull Base & Cap

M21086 (T-Mull)
M14895 (Base)
M14896 (Cap)

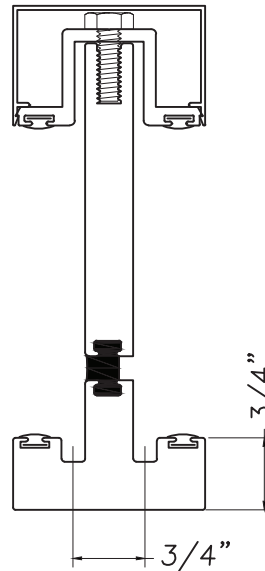

Our products are tested to the standards of and certified by the American Architectural Manufacturer's Association, the National Fenestration Rating Council and the Window & Door Manufacturers Association.



QUAKER
COMMERCIAL WINDOWS AND DOORS



QUAKER
COMMERCIAL WINDOWS AND DOORS

**ALUMINUM 3 1/4" FRAME
MULLIONS, MULL COVERS,
POST FRAMING & MULL ACCESSORIES**

Stack Mull
M21087

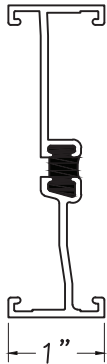

Stack Mull
M41543

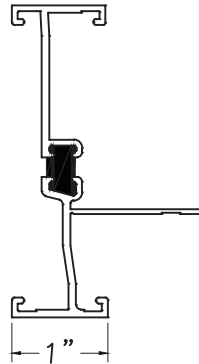

Stack Mull
M537248

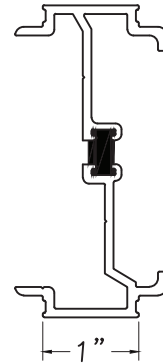

RSM Mullion
M21045 (Mull)
M21043 (Base)
M21044 (Cap)

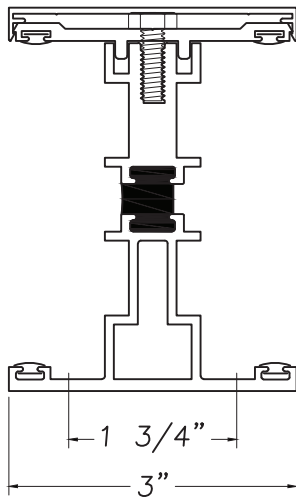

2" Side Stack Mull
M18870

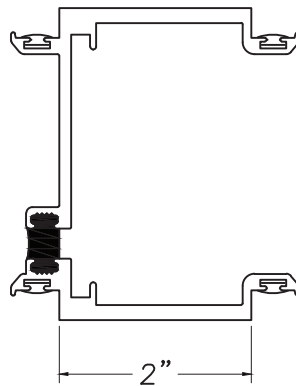

6" T-Mullion & Cover
M21344 (Mull)
M21343 (Base)
M22342 (Cap)

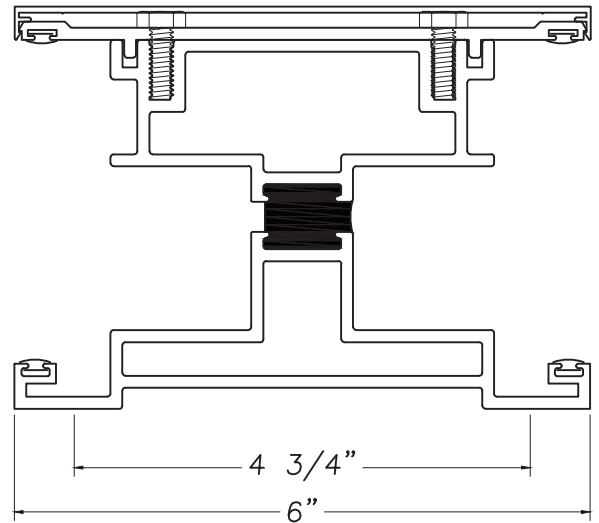

6" T-MULLION & COVER
PT# M21344 (T-MULL)
PT# M21343 (BASE)
PT# M22342 (CAP)

Our products are tested to the standards of and certified by the American Architectural Manufacturer's Association, the National Fenestration Rating Council and the Window & Door Manufacturers Association.



QUAKER
COMMERCIAL WINDOWS AND DOORS



Vertical Zero Mullion
M19935

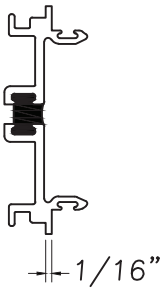

1 3/4" T-Mull w/Base & Cap

M16690 (T-Mull)
MAX17380 (Base)
MAX14141 (Cap)

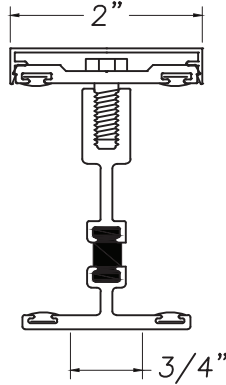

2" T-Mull w/Offset Base & Cap

M16875 (T-Mull)
MAX14895 (Base)
MAX14896 (Cap)

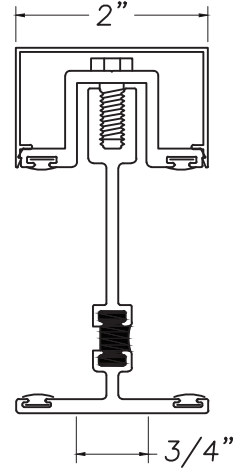

2" Structural T-Mull & 2" Mull Base

M14536 (T-Mull)
MAX17386 (Base)
MAX14141 (Cap)

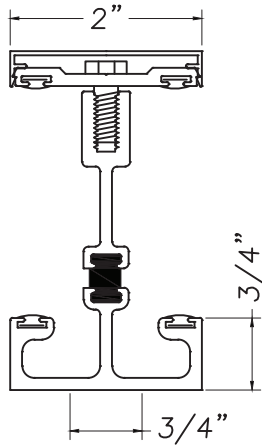

2" Structural T-Mull w/Offset Mull Base & Cap

M536203 (T-Mull)
M14895 (Base)
M14896 (Cap)

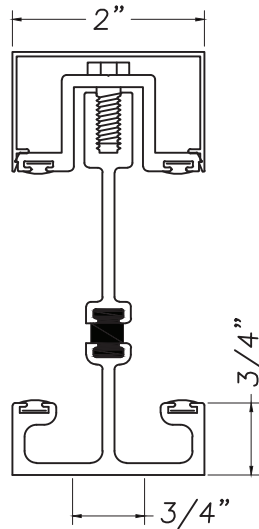

2" Spacer Mull
MAX17000

