

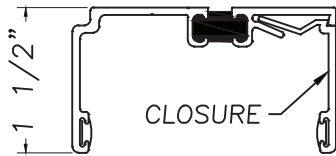

Receptor & Closure

MAX17296 (Receptor)
MAX2274 (Closure)



Flanged Receptor & Closure

M19425 (Receptor)
MAX2274 (Closure)

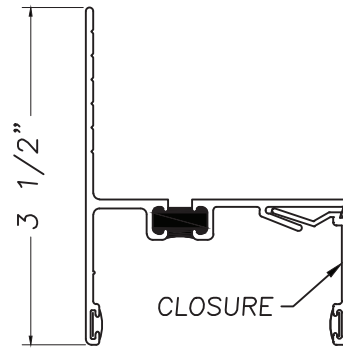

Receptor & Closer

MAX7680 (Receptor)
MAX2274 (Closure)

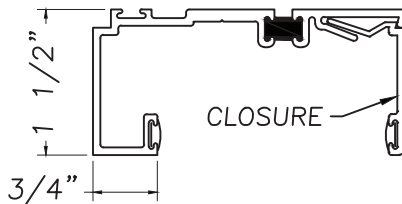

Subsill

M15877

SET IN SEALANT

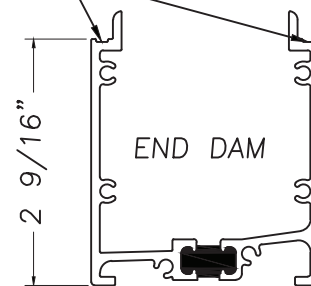

Receptor & Closer

M16531 (Receptor)
MAX2274 (Closure)

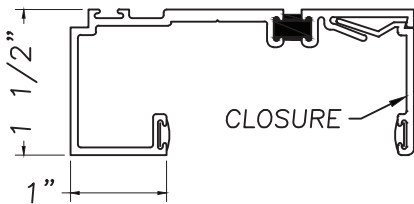



Receptor & Closure

M18141 (Receptor)
M18140 (Closure)

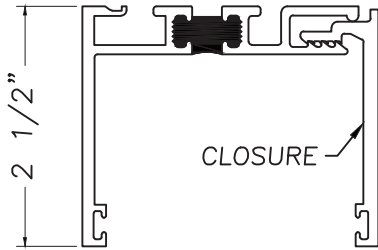

2 3/8" Expander

M16392

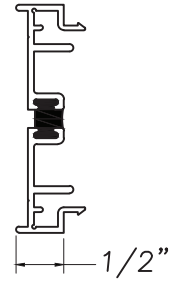

Receptor Sill

M19934

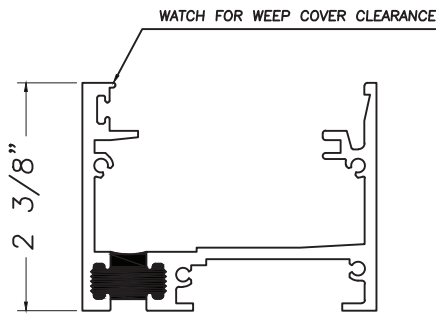

Header Expander

MAX8316

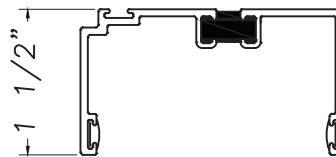



Receptor & Closure

M21048 (Receptor)
M21046 (Closure)

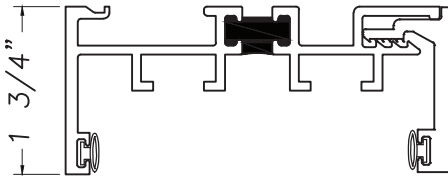

RSM Corner

M21049 (Receptor)
M21050 (Cover)
M21046 (Closures)

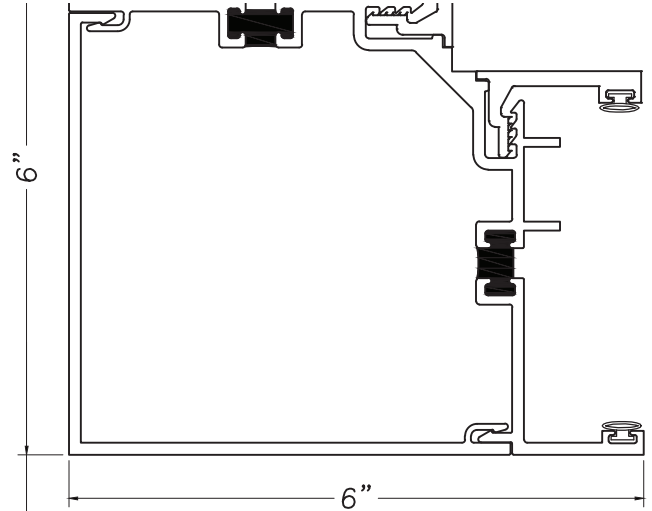

RSM 10 lb. Subsill

M21047

RSM Anchor Strap

M21092

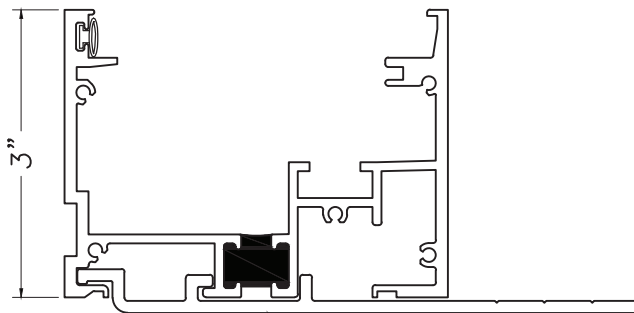

RSM ANCHOR STRAP

Subsill

M21079

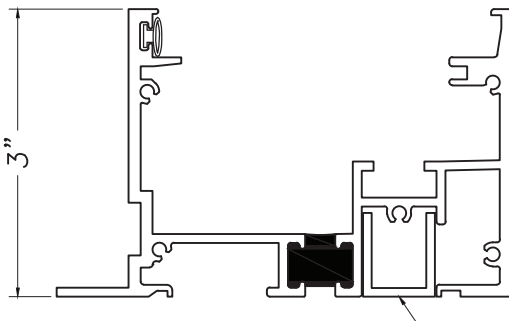

Header Expander

MAX7924

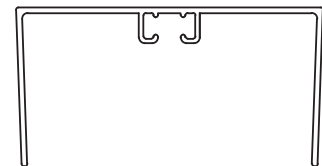



Flashing / Subsill
M541227

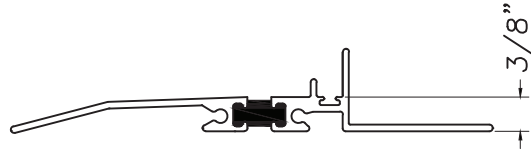

Spacer Mull or Stack Mull
M43325

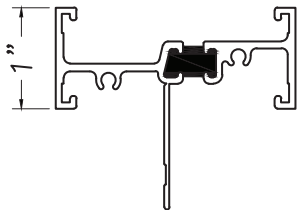

Subsill or Stack Mull
M25615

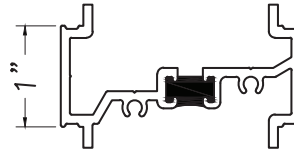

Subsill
MW23712

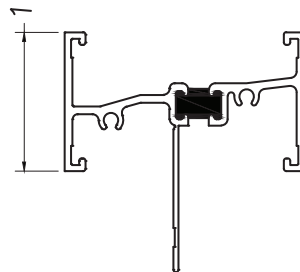



Subsill & Spacer
M16318

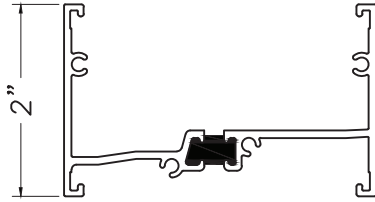

Subsill W/Fin
M17032

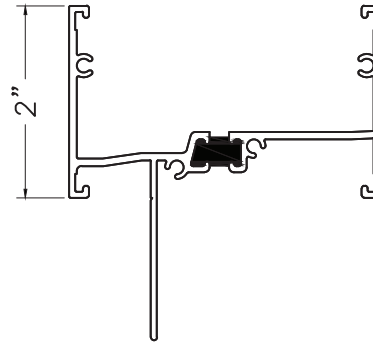

Subsill W/Fin
M21012 (Sill)
CE-13986 (C-Mull)

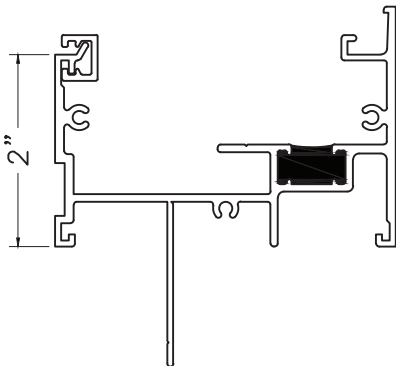

Subsill
M15731

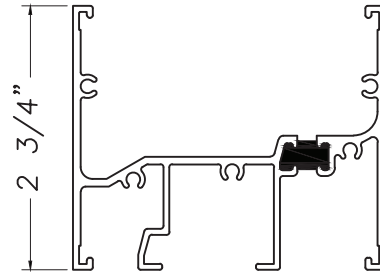

Our products are tested to the standards of and certified by the American Architectural Manufacturer's Association, the National Fenestration Rating Council and the Window & Door Manufacturers Association.

