

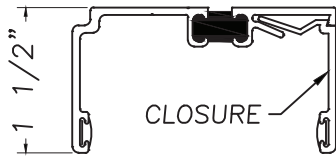

Receptor & Closure

MAX17296 (Receptor)
MAX2274 (Closure)



Flanged Receptor & Closure

M19425 (Receptor)
MAX2274 (Closure)

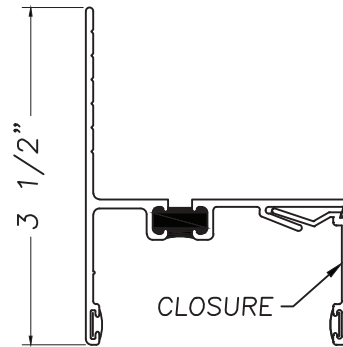

Receptor & Closer

MAX7680 (Receptor)
MAX2274 (Closure)

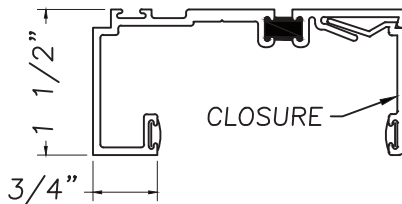

Subsill

M15877

SET IN SEALANT

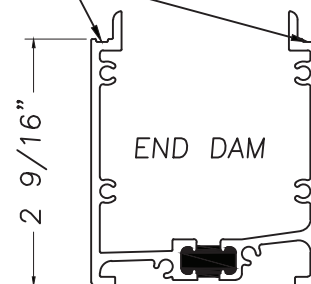

Receptor & Closer

M16531 (Receptor)
MAX2274 (Closure)

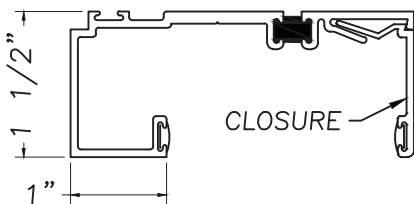



Receptor & Closure

M18141 (Receptor)
M18140 (Closure)

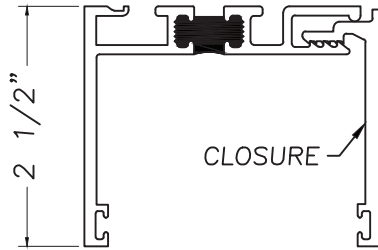

2 3/8" Expander

M16392

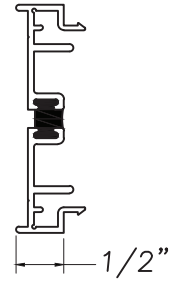

Receptor Sill

M19934

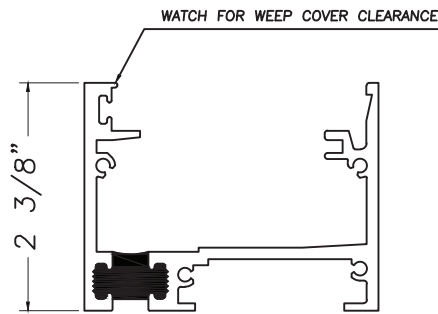

Header Expander

MAX8316

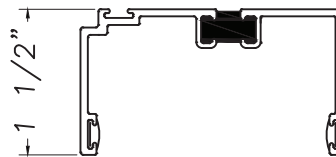



Receptor & Closure

M21048 (Receptor)
M21046 (Closure)

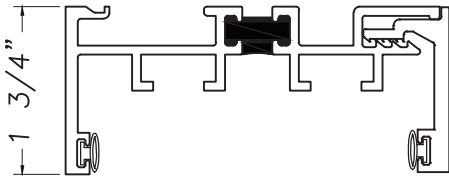

RSM Corner

M21049 (Receptor)
M21050 (Cover)
M21046 (Closures)

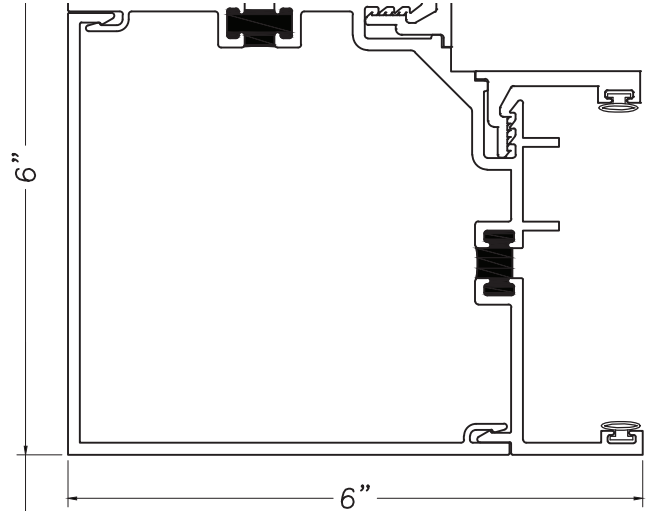

RSM 10 lb. Subsill

M21047

RSM Anchor Strap

M21092

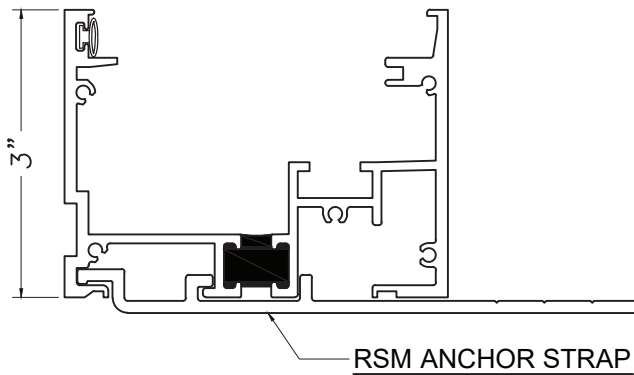

Subsill

M21079

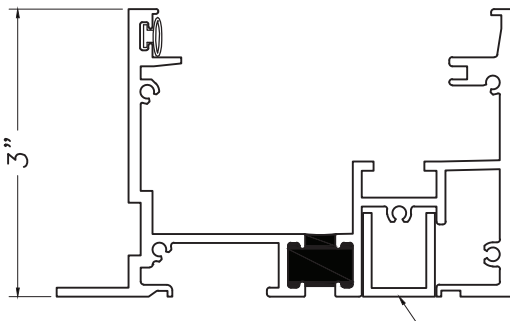

Header Expander

MAX7924

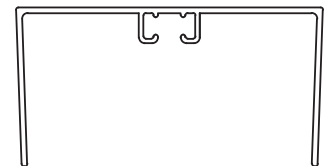



Flashing / Subsill
M541227

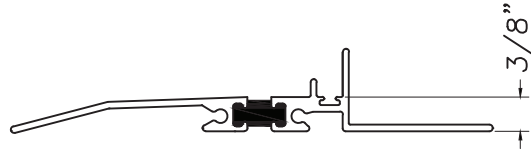

Spacer Mull or Stack Mull
M43325

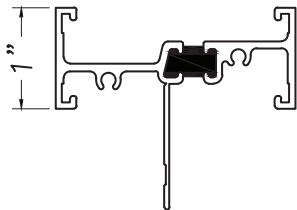

Subsill or Stack Mull
M25615

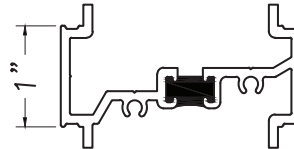

Subsill
MW23712

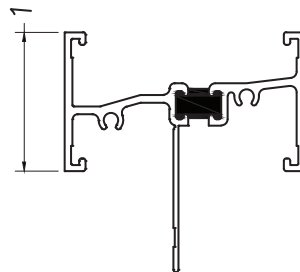



Subsill & Spacer
M16318

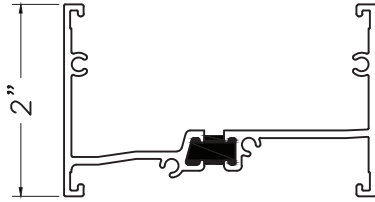

Subsill W/Fin
M17032

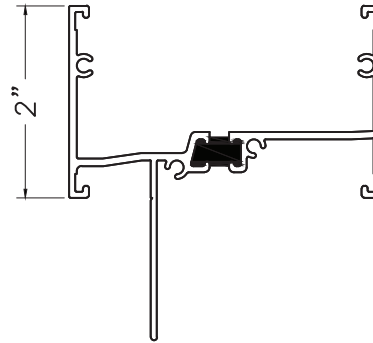

Subsill W/Fin
M21012 (Sill)
CE-13986 (C-Mull)

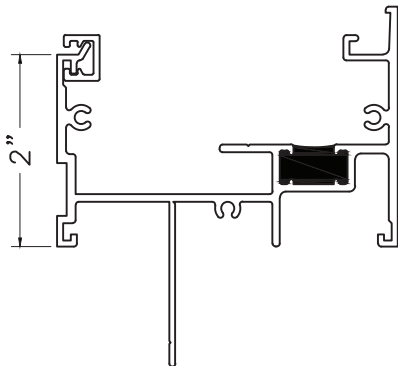

Subsill
M15731

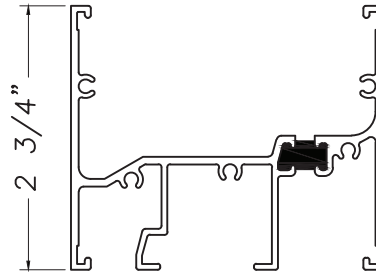

Subsill
CE-13716



Our products are tested to the standards of and certified by the American Architectural Manufacturer's Association, the National Fenestration Rating Council and the Window & Door Manufacturers Association.

